



AMC



TACOM

Precision Guided Mortar Mmunition (PGMM) XM395



1999 International Infantry & Small Arms Symposium

22 June 1999

**Presented by:
Greg Bischer
AMSTA AB FSP C**



AMC

Briefing Purpose & Outline



TACOM

- **Purpose**
 - Information briefing
- **Outline**
 - Program Focus
 - Operational Considerations and Benefits
 - Operation and Performance



AMC

Program Focus



TACOM

■ Description

- Maneuver task force commander's "hip pocket" precision indirect fire weapon

■ Capability

- First round effects out to 12km (required) 15 km (desired)

■ Target Set Focus

Threats Within Protective Cover

- **Bunkers**
 - Earth & Timber
 - Concrete
- **MOUT targets**
 - Buildings
 - Fortified sniper positions
- **Foxholes & Trenches**

Grenade Launchers (RPG-7s),
Crew Served Weapons,
Command Posts,
Observers,
etc.



■ Imperatives

- Low cost - Affordable (<\$15K per round)
- No additional force structure



AMC

Warfighter Support



TACOM

Major General Carl F. Ernst
CG USAIC



Continuous & Significant User Support

- ✓ Requirement Document Approved
- ✓ EMD & Procurement Funding in POM
- ✓ Operational Experiments Continue
- ✓ Actively Support Technology Management Process
 - ✓ **STO, DTO, etc.**

MG Ernst articulates his vision for PGMM as the maneuver task force commander's "hip pocket" precision indirect fire weapon



AMC

Battlefield Payoffs



TACOM

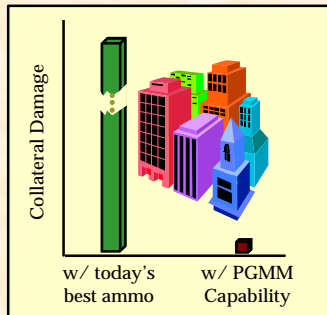

Reduced Collateral Damage

- Enables commander to engage enemy targets that are close to sensitive cultural areas
- Minimizes noncombatant casualties

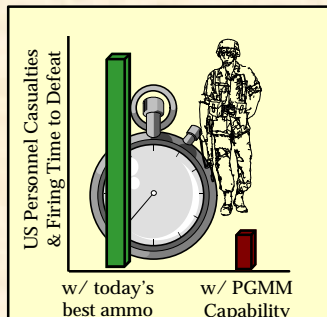

Improved Survivability & Accelerated Enemy Defeat

- Standoff kills
- Responsive kills
- One-shot kills

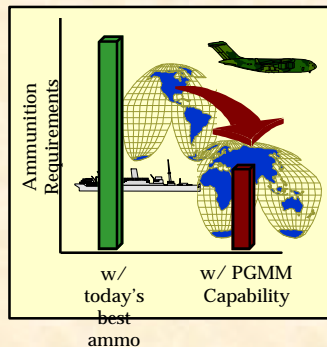

Improved Deployability & Logistics

Mortars are inherently deployable & tactically mobile. PGMM's accuracy will...

- Provide orders of magnitude increases in per round lethality
- Reduce size of logistics tail

Lessons Learned From Chechnya

Russians struggled fighting in the city of Grozny. Close air support, attack helicopters, & armored vehicles did not fare well. Direct fire, close range methods of clearing buildings adversely affected survivability. Something like PGMM would allow them to "send a bullet not a man" while still minimizing collateral damage and non-combatant casualties.



AMC

PGMM Provides Leap-Ahead Lethality



TACOM

Number of Rounds Required to Defeat Small, Protected Target vs. Range

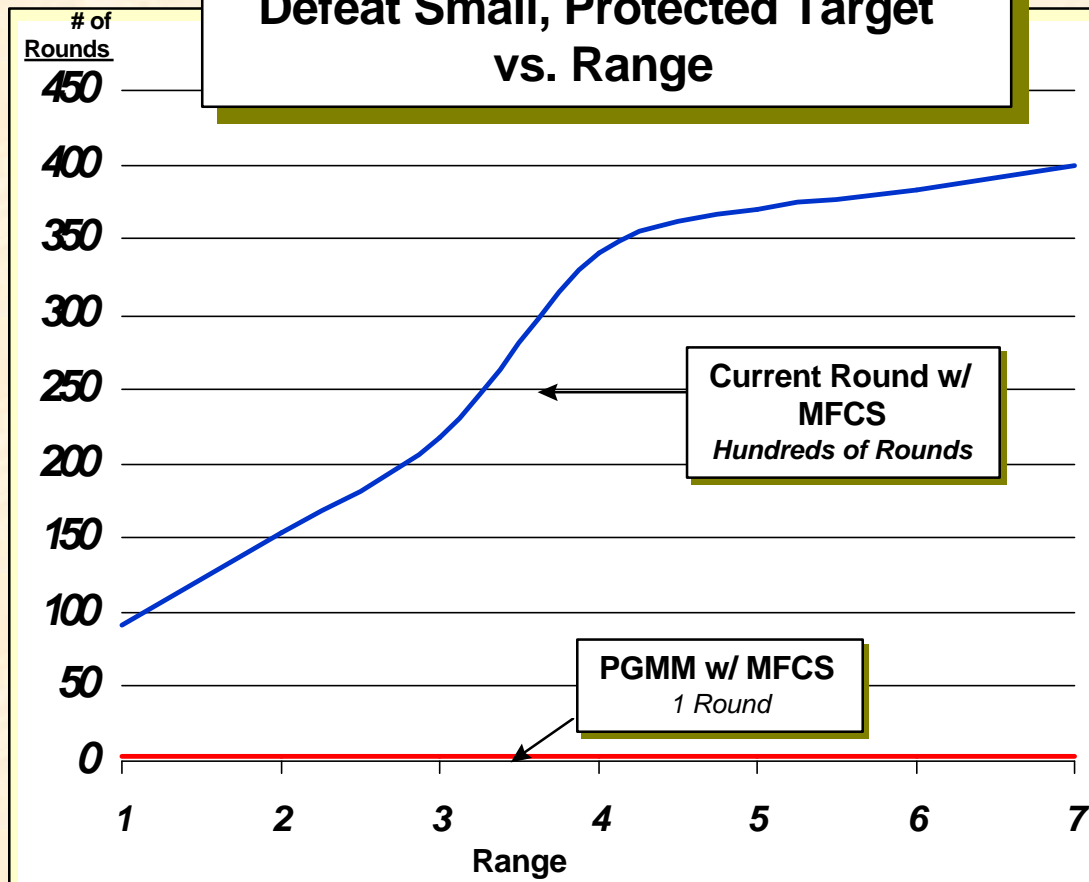

- Problem gets worse if you are trying to defeat relatively small, protected targets.
- Practical limitations would preclude the use of current rounds against such targets
 - Between 100 & 400 unguided rounds are required to defeat a small protected target.
- A precision guided mortar would enable defeat of a small, protected target with only one round.



AMC

Quantifying Combat Utility



TACOM

Recent series of warfighting experiments suggest...

- Reduced Collateral Damage
 - Enabled engagements of targets close to culturally sensitive areas, non-combatants, or friendly troops
- Improved Lethality
 - ~10x increase in indirect fire kills
- Improved Survivability
 - ~50% improvement in blue force survivability
- Improved Deployability & Logistics
 - ~40 % reduction in number of rounds fired
- Accelerated Enemy Defeat
 - Significant reduction in time required to complete mission



Quality time with users... very valuable feedback

Warfighting Experiments - M&S

- **Primary Goal**
 - Continue to quantify the battlefield utility
 - non-armor intensive type scenarios
 - unique and valuable combined arms asset - significantly contributes to success of maneuver task force.
- **Secondary Goal**
 - Obtain Operational Insights (DTLOMS Impact & TTP development)
 - Support system design trade-off analyses (balance cost & performance)
- **General Approach**
 - Constructive Simulations in JANUS & CASTFOREM
 - Urban & Rural Terrain / Light & Heavy Infantry
- **Near Term Sub-Experiments (JANUS)**
 - ✓ October 98 HR55 Vignette / Rural Heavy
 - ✓ January 99 Rangers ARC JRTC
 - ✓ May 99 MOUT ACTD
 - August 99 HR49.x Vignette (Certified)
- **Next Step**
 - Continue building vignette library
 - Port JANUS HR4.9X runs to CASTFOREM early FY00



AMC

Growing Infrastructure Supporting PGMM



TACOM



MFCS: Digital Fire Control



Commander's Interface



Pointing Device



Driver's Display



Gunner's Display



PGMM...
An Integral Part of
Modern Battalion
Indirect Fire

■ Fielded or WRAP Programs

– Observers

- Light-weight Laser Designator Range Finder (LLDR)

– Fire Control / C4I Links

- Mortar Fire Control System
 - Linked to AFATDS / Embedded Battle Command

– 120mm Mortar Platforms

- M121 (carrier-mounted)
- M120 (towed mortar)

■ Other encouraging signs

– Growing likelihood of adding 120mm mortar to the light forces

- Arms Room Concept
 - 10th Mountain Division
 - 75th Ranger
 - US Marine Corps

– Turreted Mortar



AMC

Operation & Performance

(Tech Demo Configuration)



TACOM

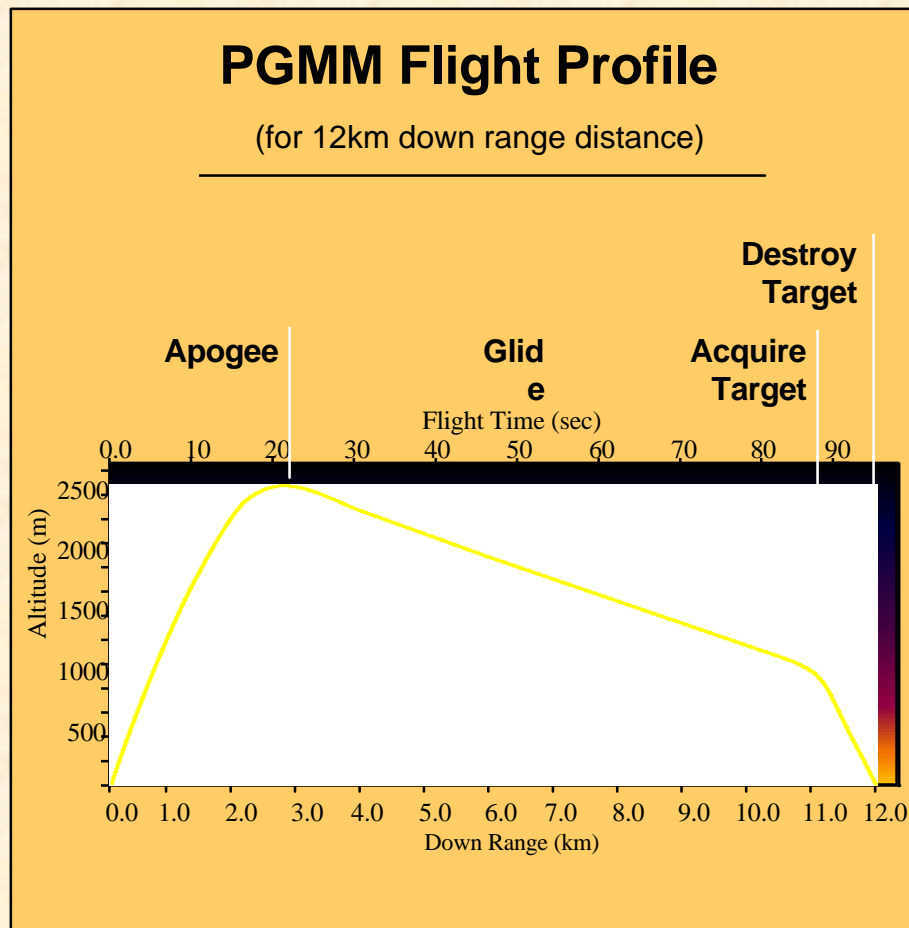

■ Operational Sequence

- Drop fired
- Fins Deploy (<80ms)
- Wings Deploy at Apogee
- Glide for Extended Range
- Gyros sense in-flight location
- In-flight corrections made to guide to predetermined in-air “basket” (500m x 500m footprint on ground)
- Scans for laser designator energy on target
- Maneuvers to attack at optimum impact angle & at most vulnerable point.

■ Performance Goals

- Accuracy: 1m
- Range: 0.5km - 15km
- Weight: <40 pounds
- Length: < 40 inches
- Unit Cost: <\$15K



AMC

Major Subsystems

(Tech Demo Configuration)



TACOM

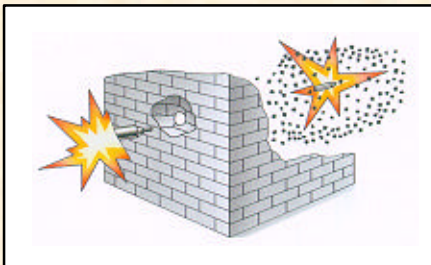
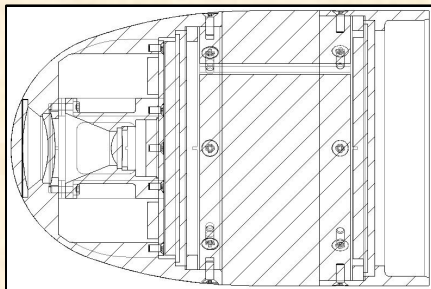
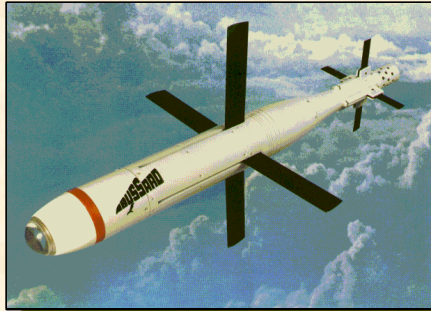

- **Projectile / Guidance & Control**
 - Strapdown G&C Subsystem
 - Low-Cost, Body-Mounted Gyros
 - Fin Actuated Control System
 - Post Launch Initialization
 - Extended Range Glide ←
 - Proportional Terminal Guidance
 - GPS/INS Assembly (*Under Investigation*)¹

- **Seeker²**
 - Linear Position Measurement Sensor (Not a Quad)
 - Hi-G Survivable
 - Strapdown ←
 - Real Time Processing / Code of the Day

- **Warhead**
 - Optimized for threats behind protective cover
 - Concept TBD

Glide capability provides extended range without added cost, weight, & complexity of a rocket motor

Theoretically superior design concept to gimbaled quad design
Increased Reliability (No moving parts)

1. Tech demo will demonstrate GPS via simulation
2. Tech demo will demonstrate strapdown laser seeker via live fire demonstration



AMC

Airframe



TACOM

- **Based on German Bussard round**
 - Diehl
- **Being modified to meet PGMM requirements**
- **Stepwise approach to qualification**
 - Fin Deployment Testing
 - Wing Deployment/Ballistic Testing
 - Range and Stability Experiment

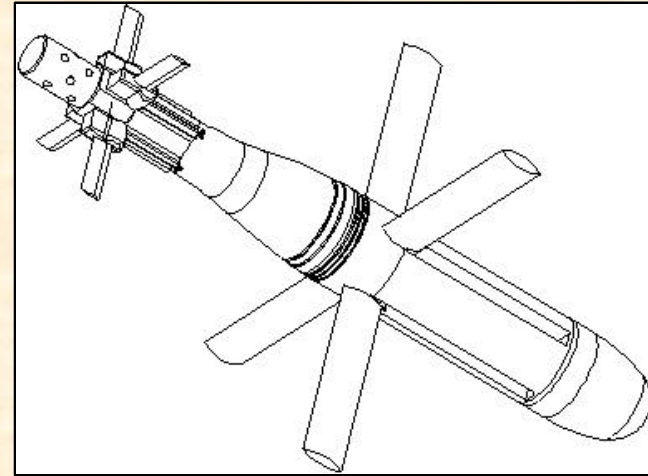



AMC

Seeker Subsystem



TACOM

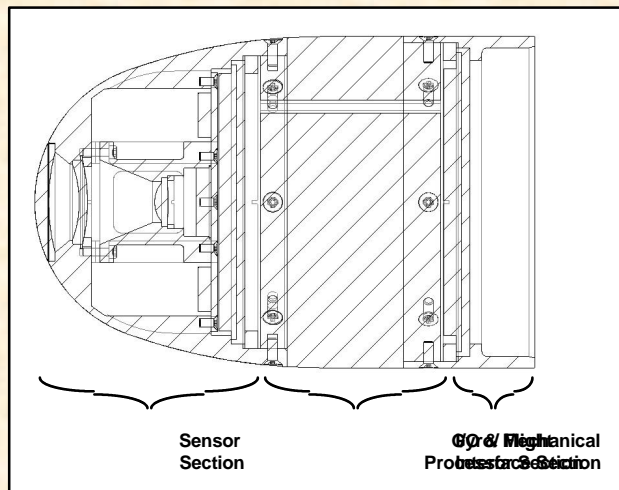

■ Features

- Inline optics (window, 2 lenses)
- Linear Position Measurement Sensor (Not a Quad)
- Strapdown (improved reliability and survivability)
- Real Time Processing / Code of the Day
- Detector mounted directly onto electronics card to improve noise control

■ Status

- Baseline design complete
- 3 different detectors being characterized (FEB - JUL 99)
 - Noise
 - Bandwidth
 - Response / Detectivity
 - Complexity (# of outputs)
 - Cost
- Select Detector (SEP 99)



AMC

Gyro Subsystem



TACOM

■ Subsystem Components

- 3 Gyros (x,y, z)
- Flight Computer
- Clock
- Power Supply

■ Gyro Vendor

- C.S. Draper Labs

■ System can be easily upgraded to incorporate GPS

■ Status

- Operated during wing deployment shock laboratory test
- Building units for subsystem High-G test (July 99)

■ First operational flight test planned for Feb 00 (wing deployment flight testing)

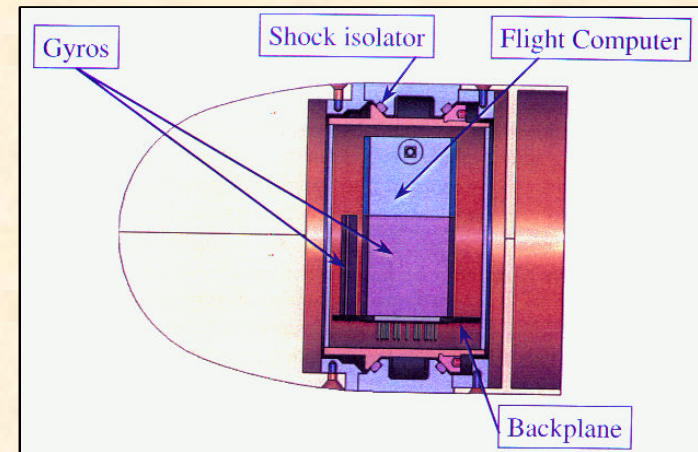

Subsystem Location

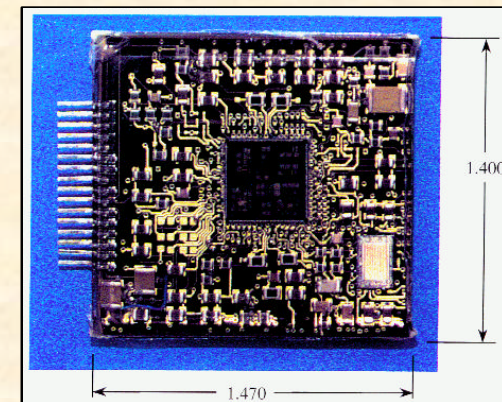

Gyro ASIC



AMC

PGMM Guidance Study



TACOM

- Purpose: Evaluate various guidance options to determine the payoff of accuracy versus cost for a potential EMD solution for PGMM.
-
- Guidance options being considered:
 - Gyros only
 - Full INS
 - GPS* + Gyros
 - GPS* + INS
-
- Analysis being done for 2 km, 4 km, 6 km, 8 km, 10 km, 12 km and 14 km flight ranges
-
- * GPS options will be studied with various levels of jamming resistance and recoverability.

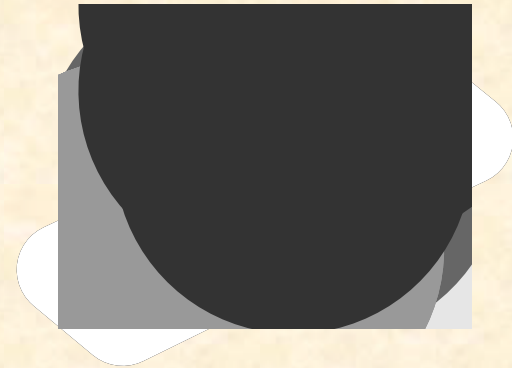



AMC

PGMM Program Schedule



TACOM

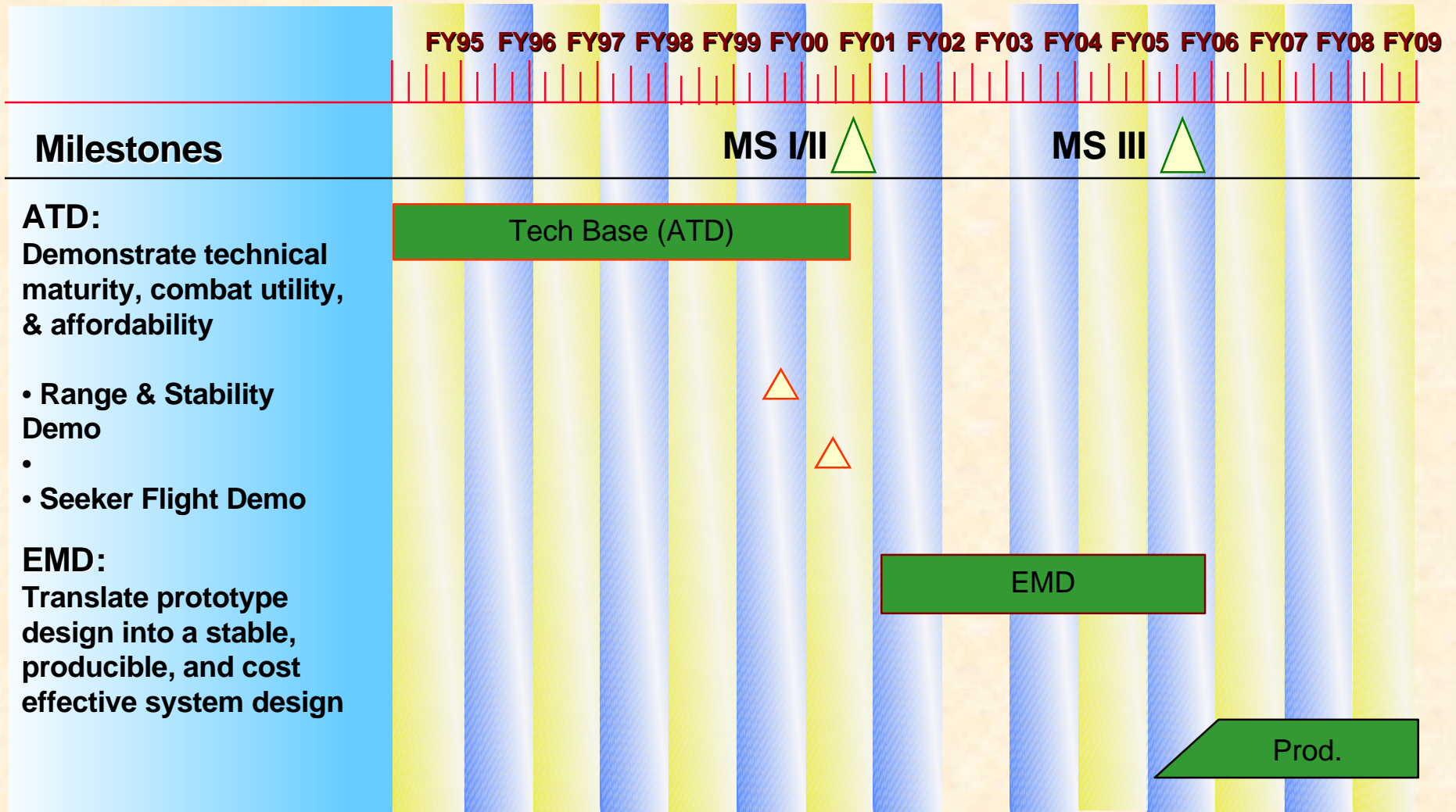



AMC

Summary



TACOM



■ Concept

– Description

- 120mm laser guided projectile with extended range glide capability

– Capability

- Responsive, precision, standoff defeat of bunker and MOUT targets

– Battlefield Payoffs

- Improved survivability
- Reduced collateral damage
- Accelerated enemy defeat

■ Program

– Demonstrated technical progress and combat utility

– Continuing technical and operational experiments

– EMD Funding in POM with MS I/II decision in FY 01